



18 Design
Portfolio

Saurav Pandey

Transportation Design



"Every living being is a designer in someway."

Hello / Namaskar!

I am Saurav Pandey, 20 years of age
3rd Year UG Transportation Design Student
DYP-DC School Of Design, India

Design and Art Have always been a part of my life since childhood, for me Design is about helping people and solving problems using my creativity and knowledge. I have always been a keen learner and observer, always curious and excited to learn new and different things as well as learning from other people and their knowledge in any field.



Art



Rides



Trekking



Protologue

This portfolio mainly showcases my skills that I have developed in these two years.

The variety of these projects have helped me in understanding different vehicle segments and their architecture.

Education

2003 - 2014

The Bishop's School

2014 - 2016

Nowrosjee Wadia College (Science)

2016 - Present

DYP-DC School of Design

Languages

Hindi (Fluent)

English (Fluent)

German (Basics)

French (Basics)

Master Class

Opel - Gregory Hill Young

3 segments Interior

(Quick projects)



Skills

Adobe Photoshop 8/10

Adobe Indesign 6/10

Adobe Illustrator 6/10

Hand Sketches 8/10

Marker Renderings 8/10

Painting Mix Media 8/10

Experience

4 months : Smilemiddle.com

Portraitist 

3 months : Mfable Creative Lab

Design Intern 

Contact

sauravpand98@gmail.com

+91 966 517 2274

+91 800 710 9303



1

Renault 2022 Hatchback

Personal Project



2

JCB Skid Steer Loader

Personal Project

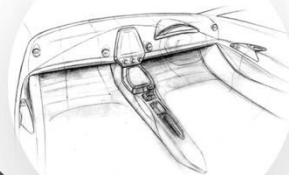

3

Suzuki Interior 2022

Team Project

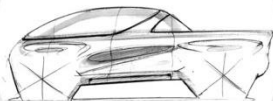

4

Bharat Benz Pick-Up

Personal Project



5

Miscellaneous



1

Renault 2022 Hatchback

Personal Project - 1 Month

Revival of The Revolutionary Renault 16



Understanding Renault 16



Why Revolutionary and Iconic?

1965 : The first family car by Renault.

The first production car in the world to feature a hatchback.

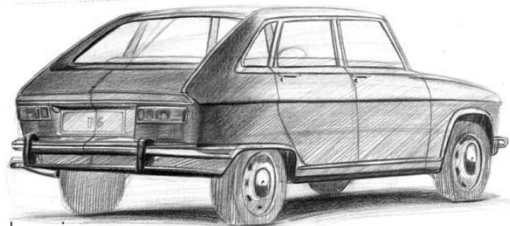

"Pagoda Inspired Hatch"

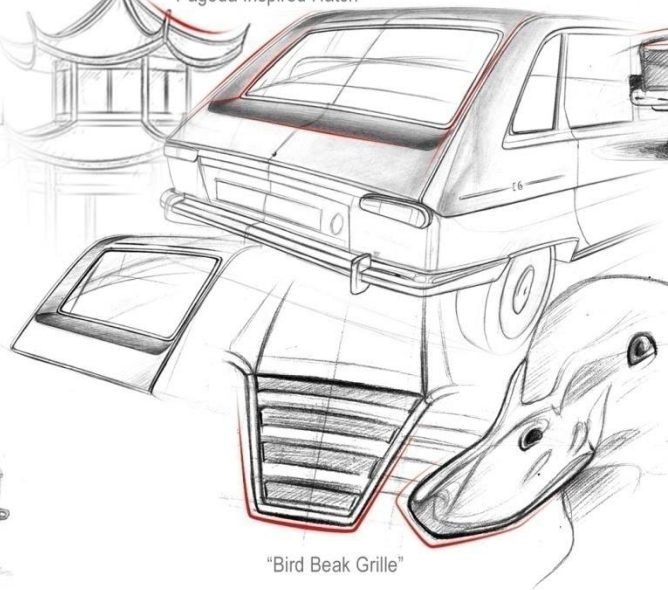

"Bird Beak Grille"

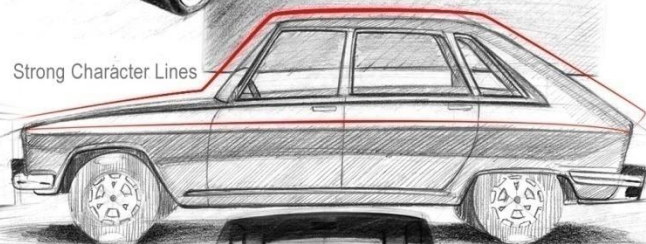

Strong Character Lines



4 Headlamps

MoodBoard

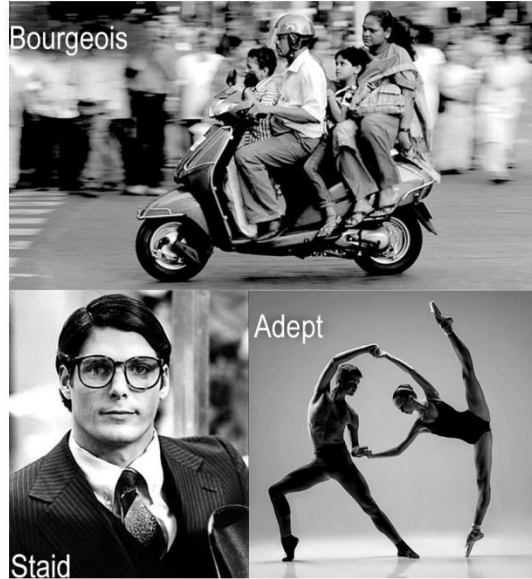

Scenario

In 2022 Renault Revives Its Iconic hatchback Renault 16 with an electric hybrid powertrain for middle class Indian families.

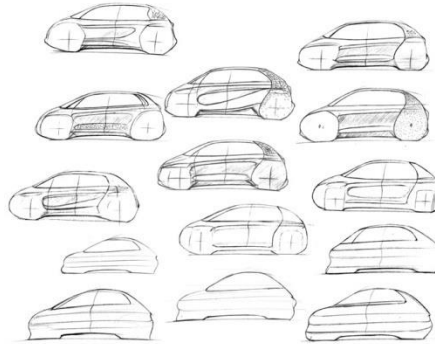

Inspiration & Design Language

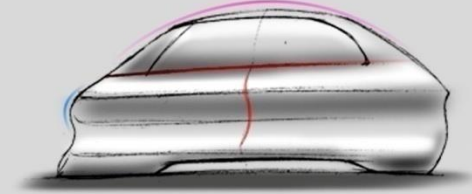
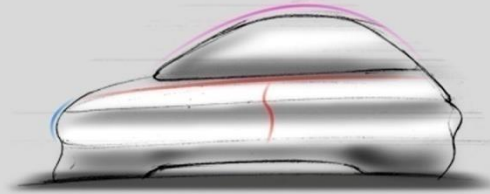
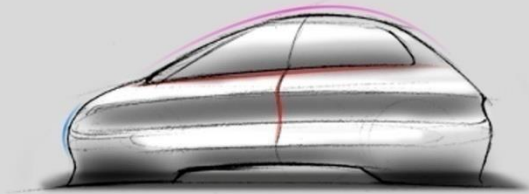
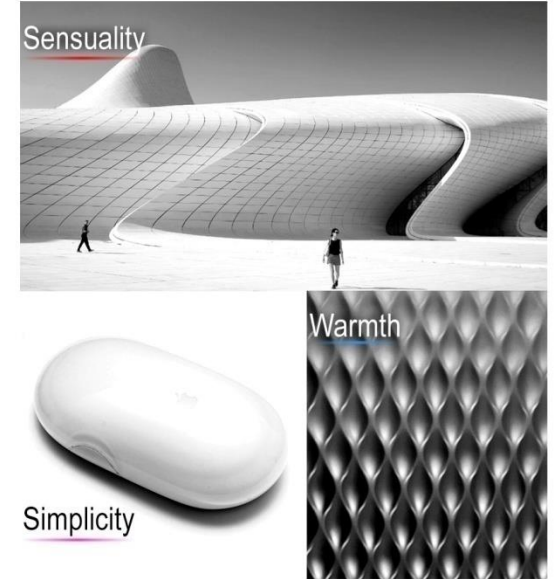

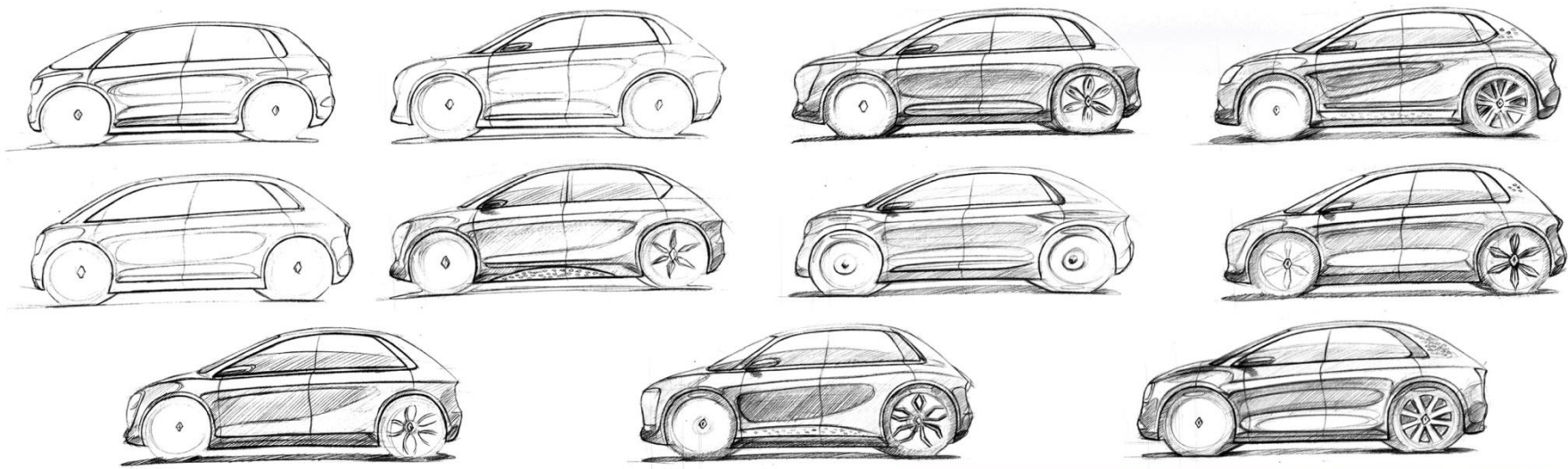

Maintaining the original
Renault 16 Form

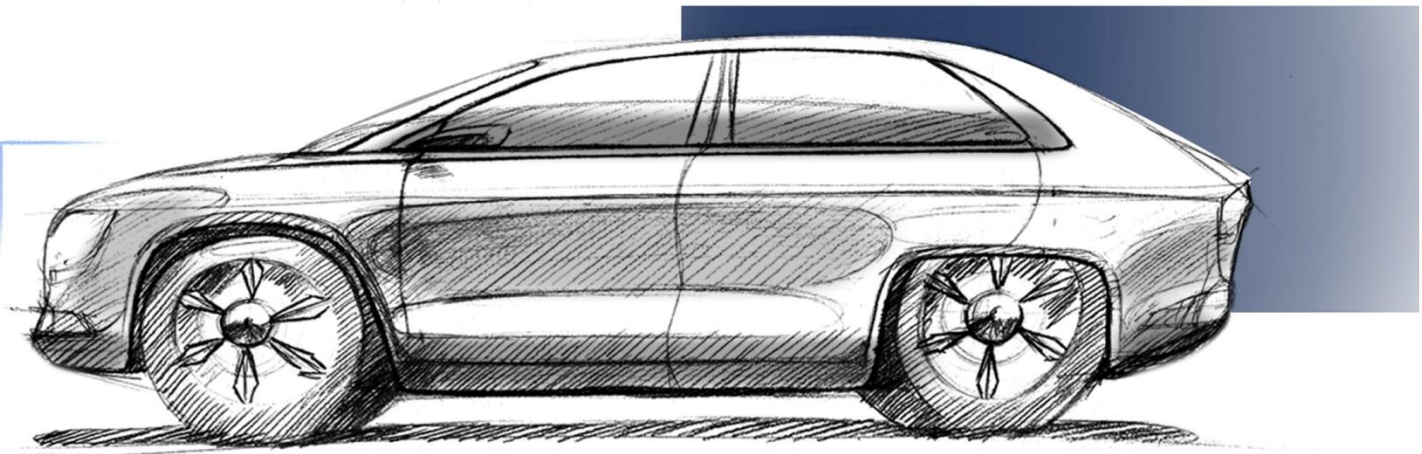



C - Shaped headlamps

Large Logo

Signature Renault Elements

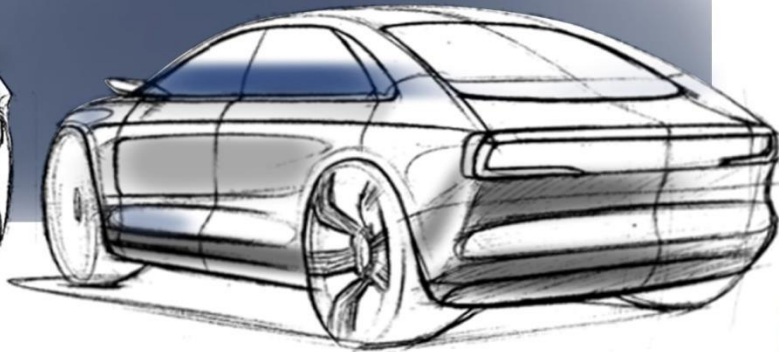
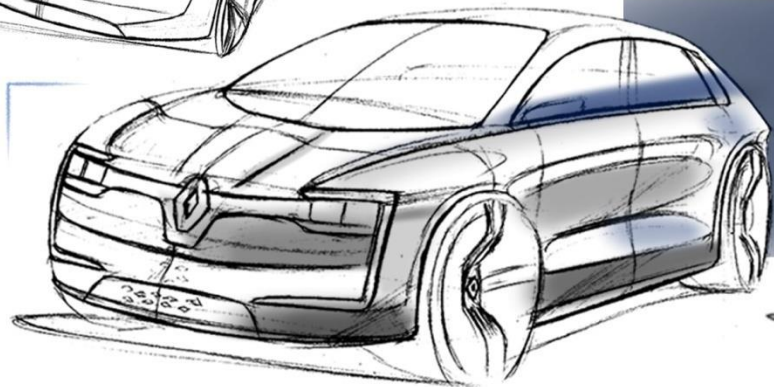
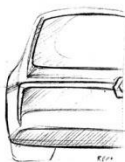
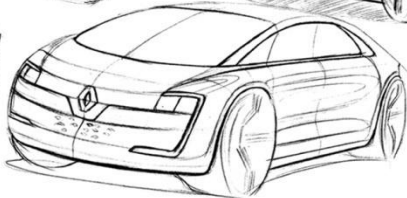
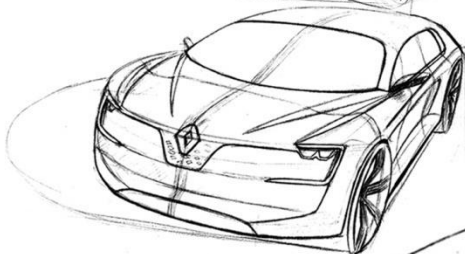
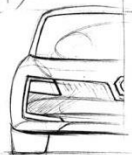
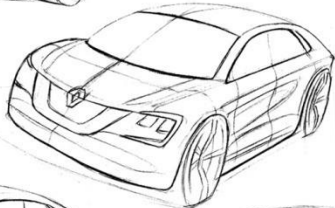
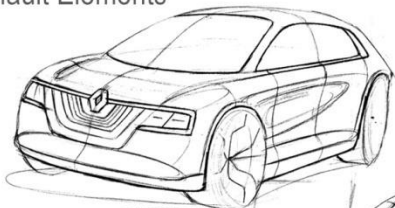
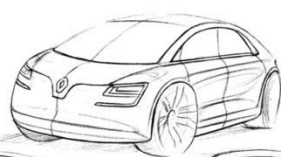
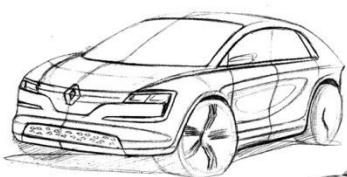
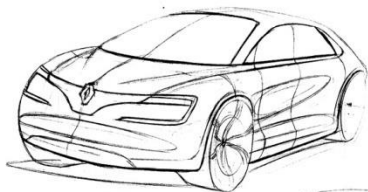

Development

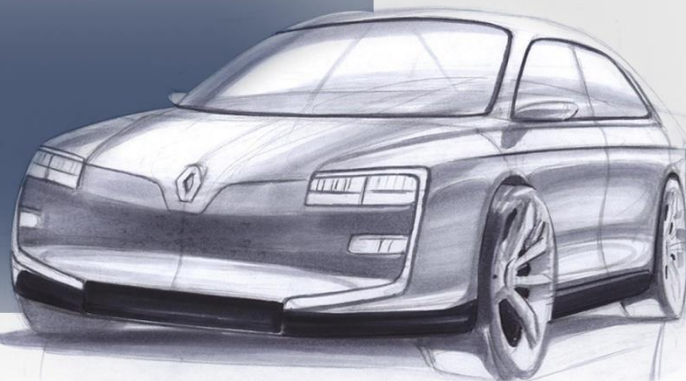
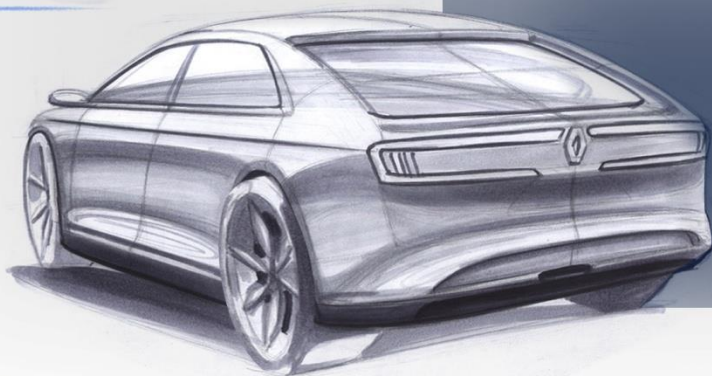
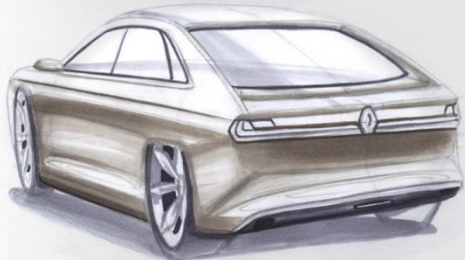
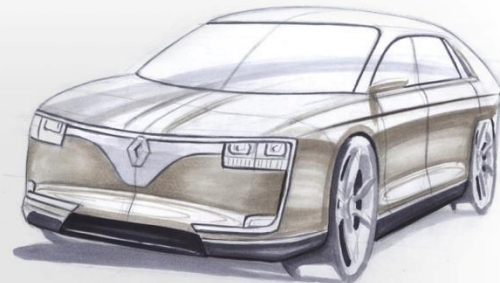
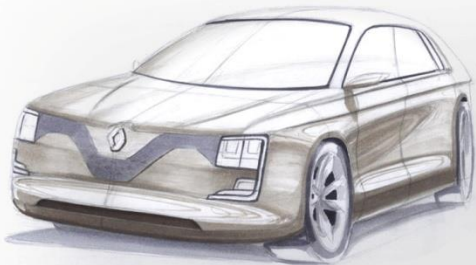



RENAULT
Passion for life



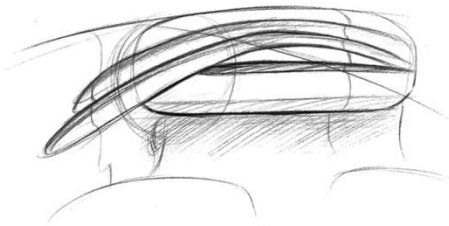
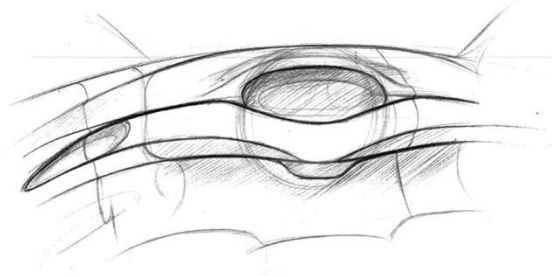
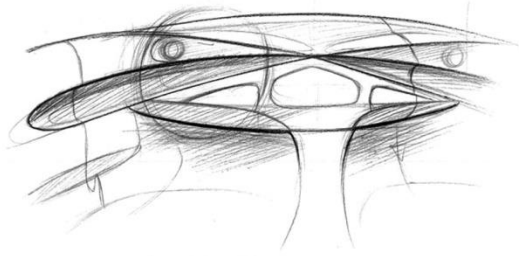

8 MOUSE FORM

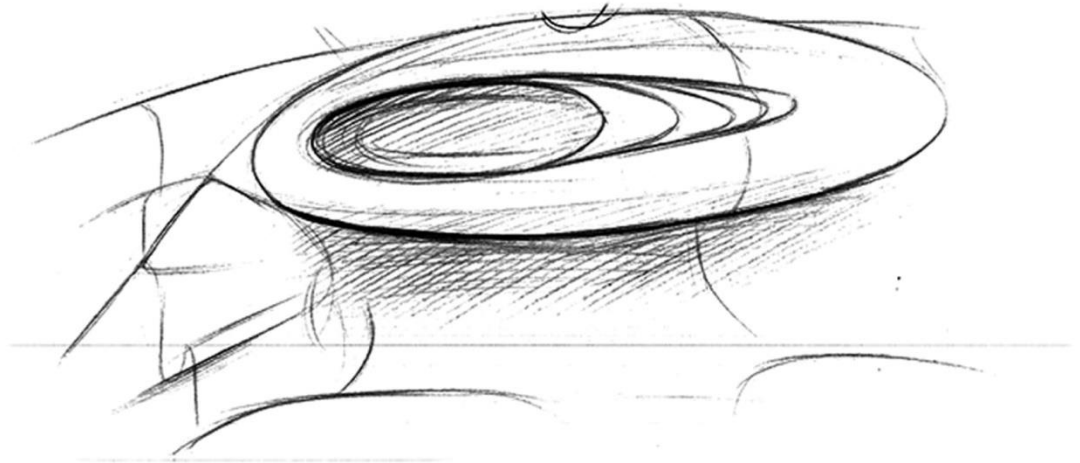
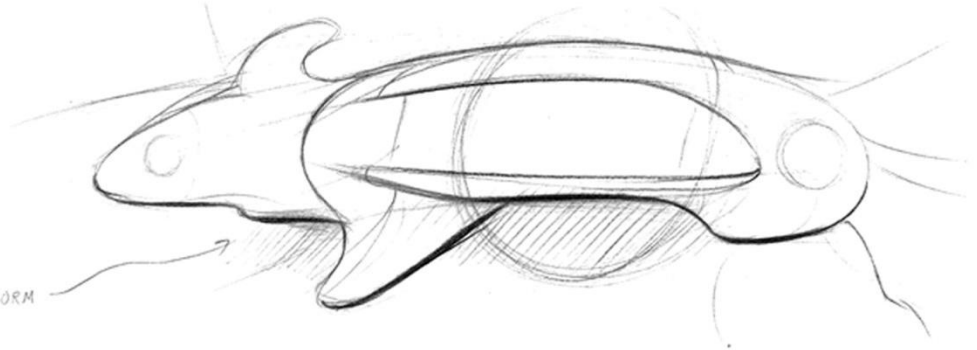

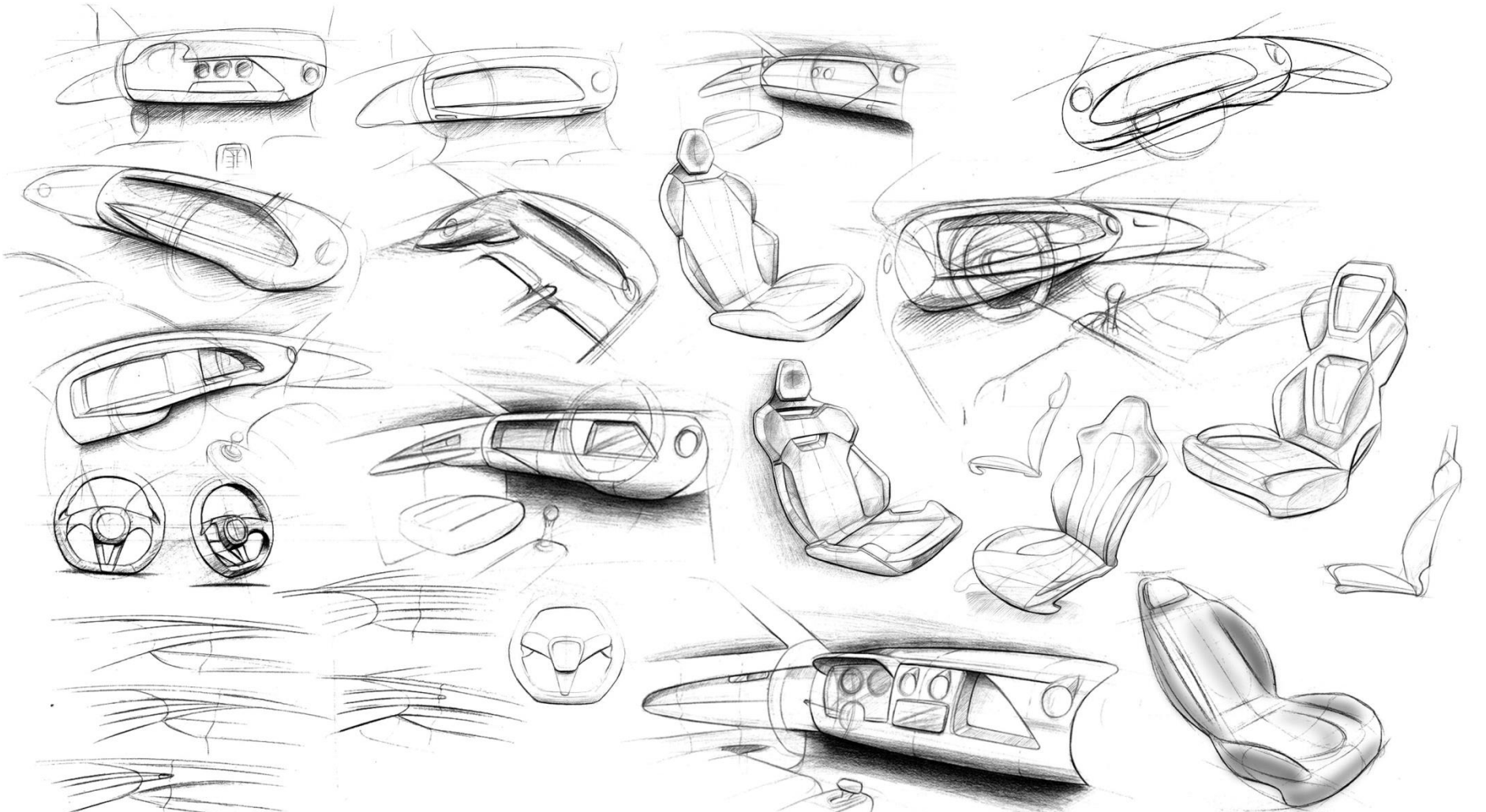

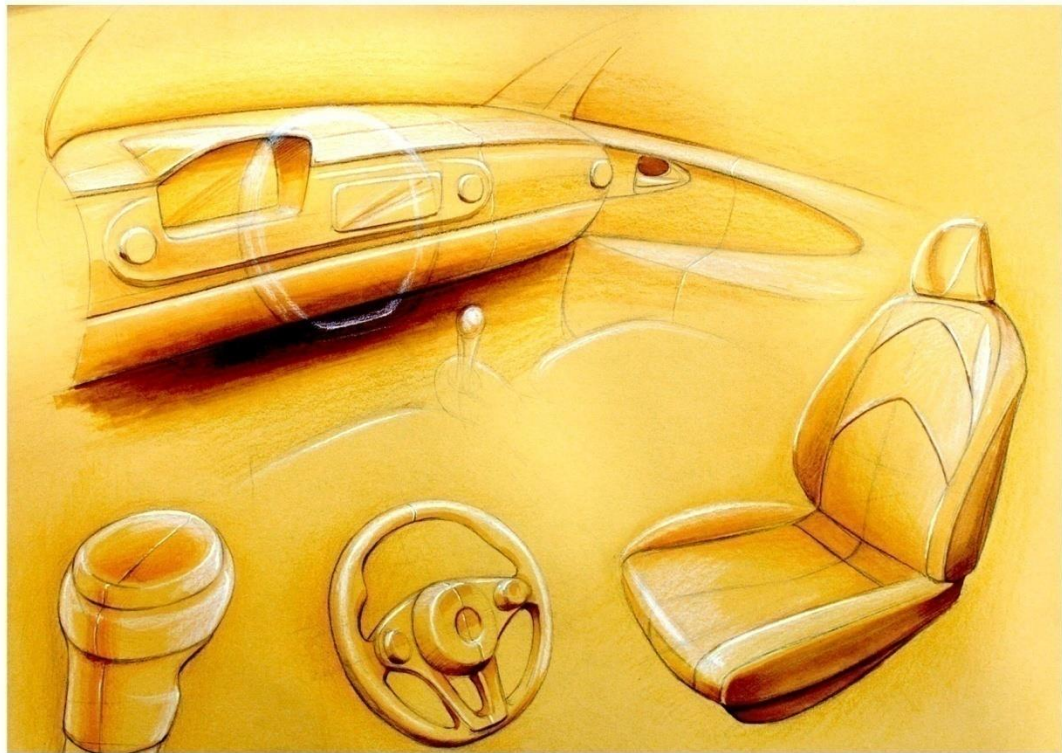
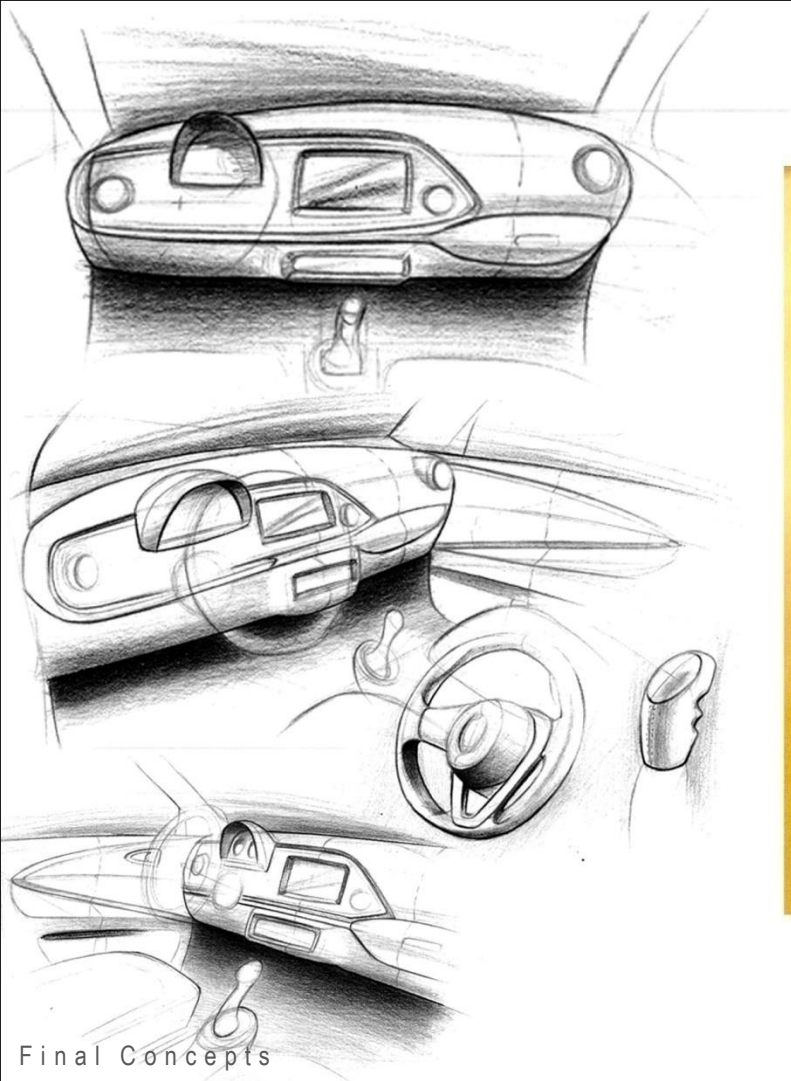



2

JCB Skid Steer Loader

Personal Project - 1 Week

Loader Inspired by Nature and Expressions for the future where Aesthetics will play a bigger role in the Construction & Agriculture Vehicle Business.



Current Scenario

Current Generation vehicles lack aesthetics because their main purpose is function.

Idea

If we build aesthetic construction vehicles along with modern technologies, in the future it will attract the modern generation to get into this business.



Curvy
Expressions

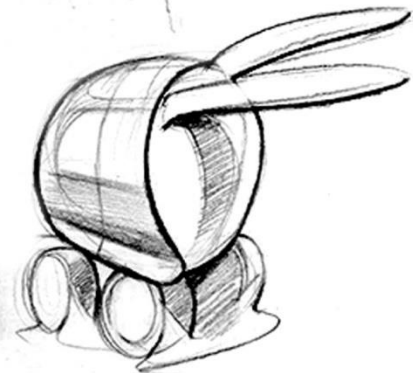
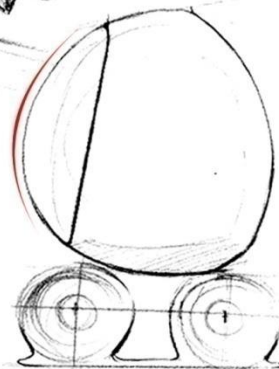
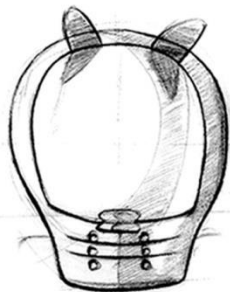
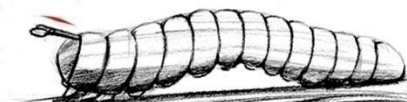
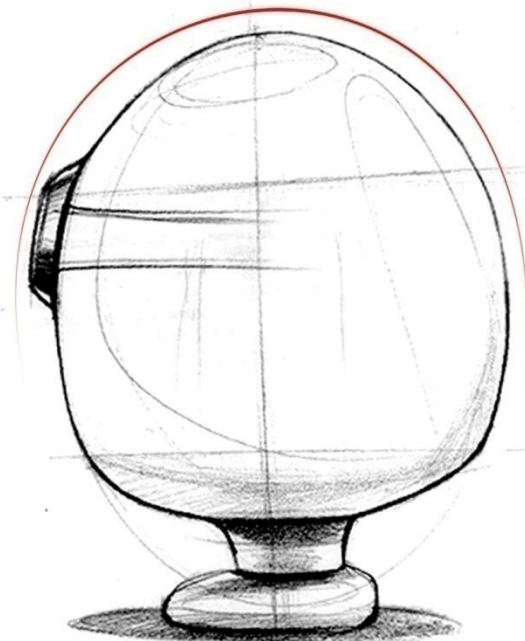
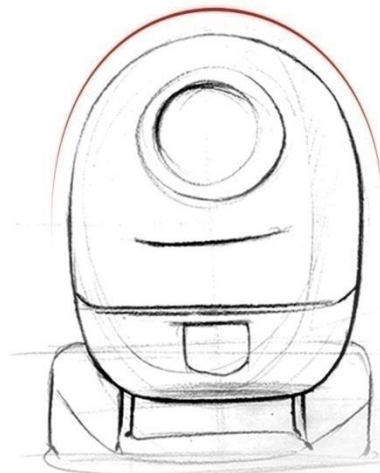
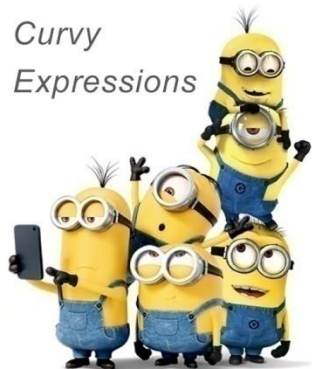

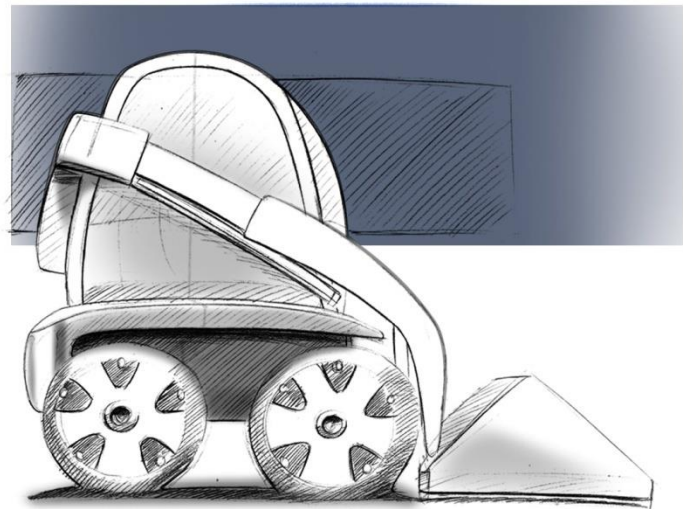
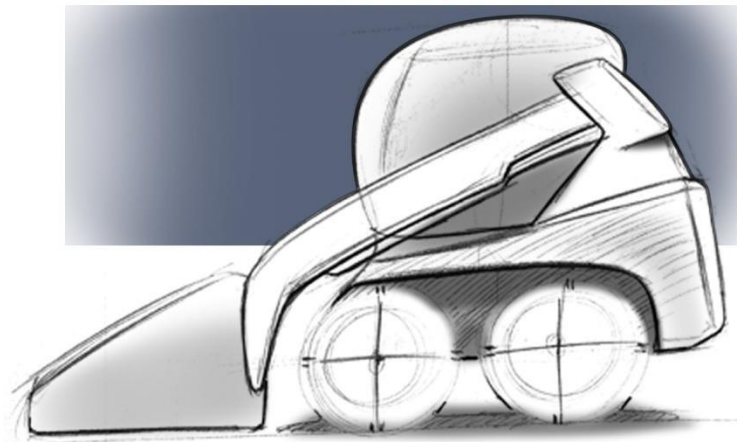
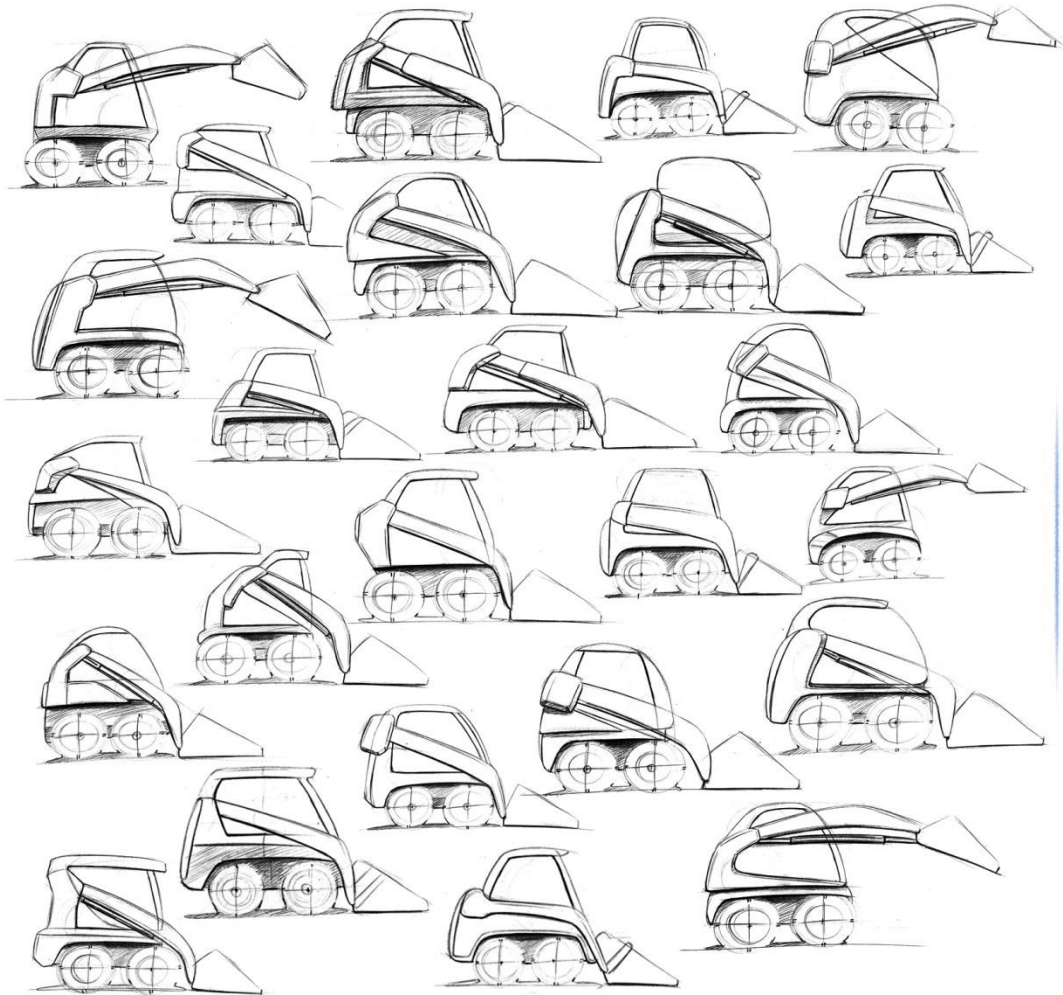

Development

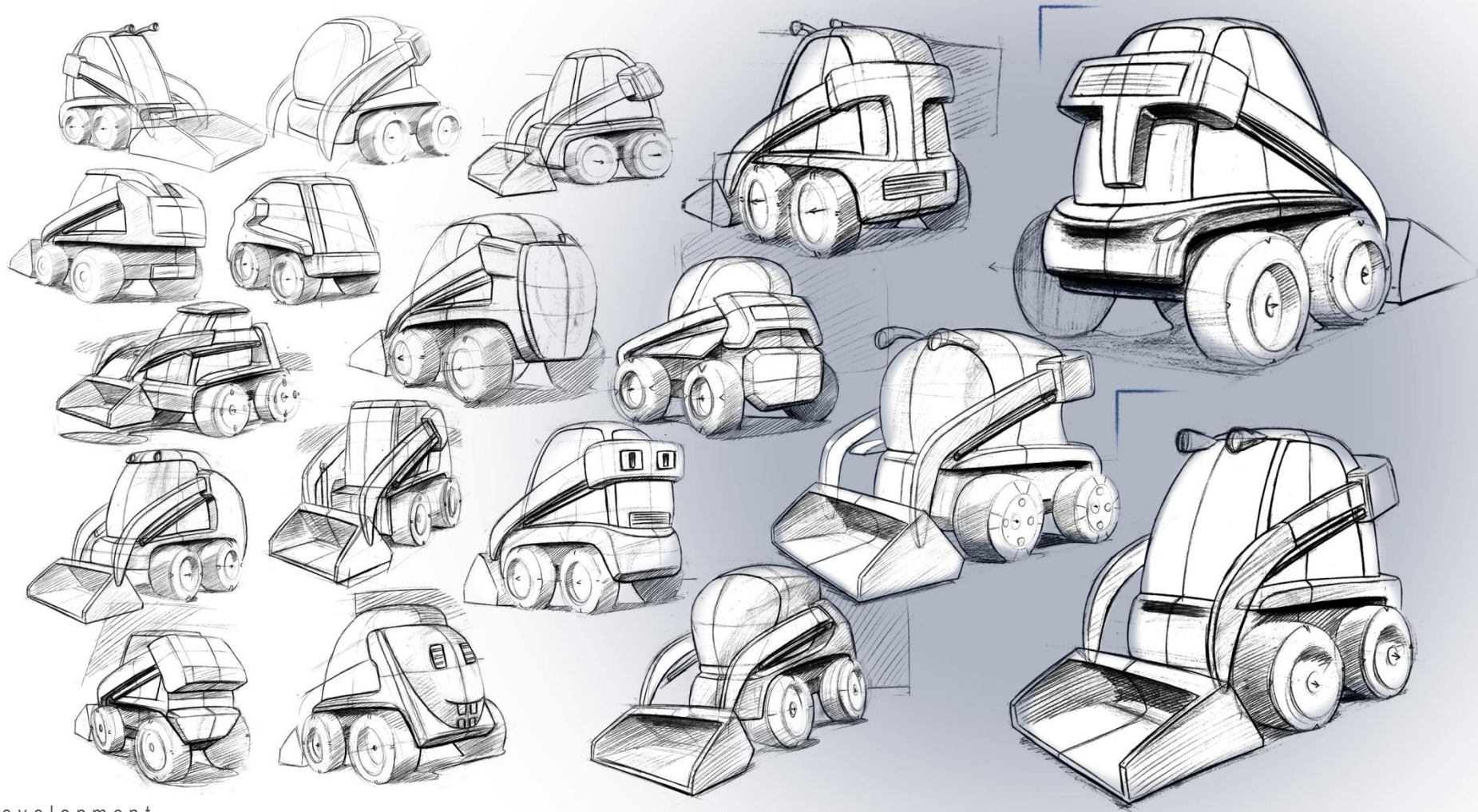

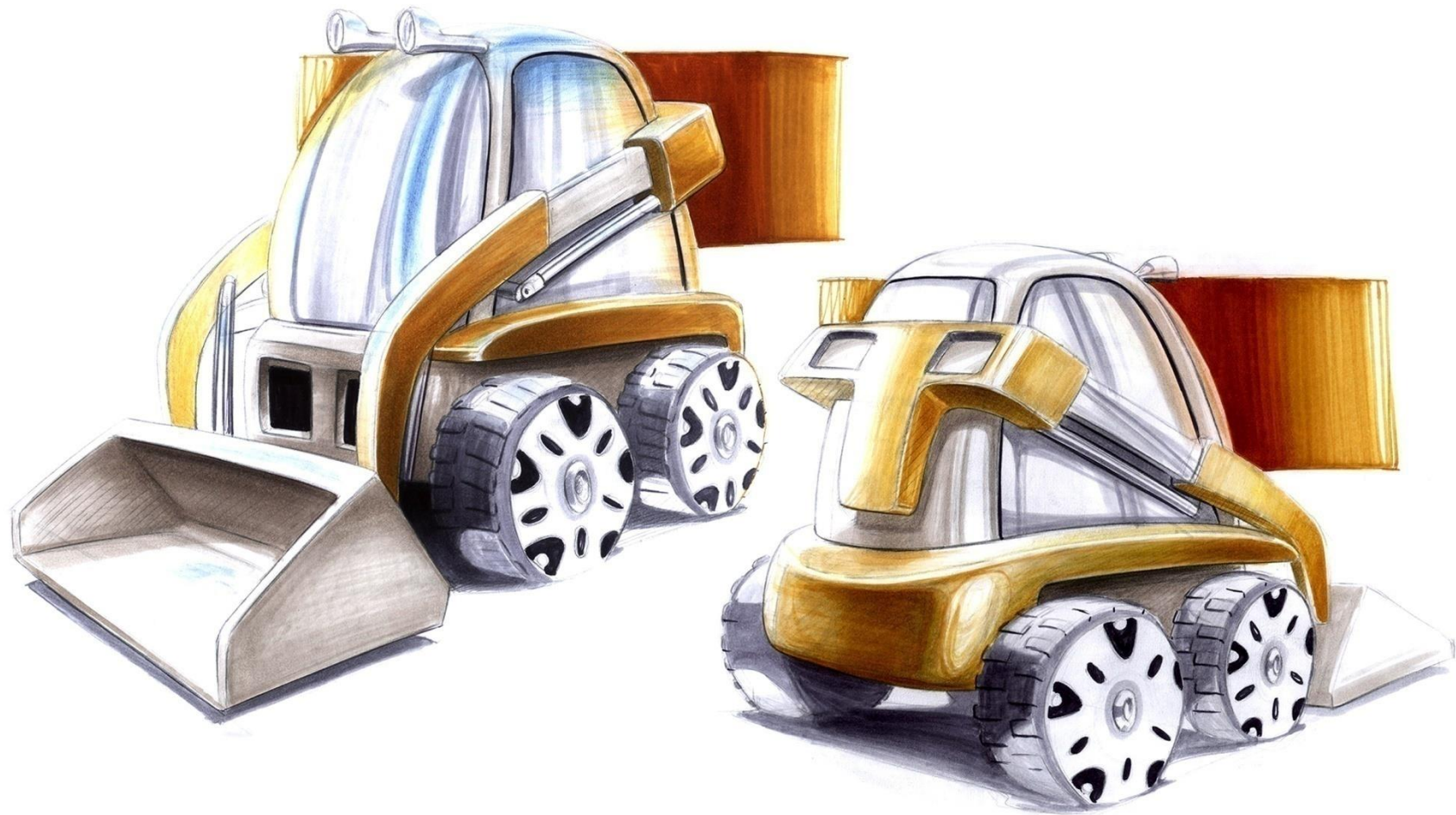



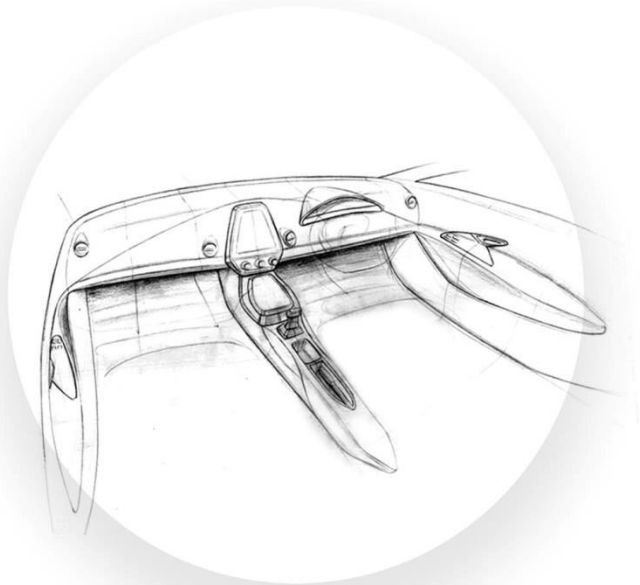

3

Suzuki Interior 2022

Team Project

My Role : Leader

Members : Onkar K, Robin R, Shubham S, Saurav P

Small Car Interior for the Indian Market

Inspired by "India".



Pure



Simple



Harmony



Innovative



Way of life



Interior Design Language "Symmetry"

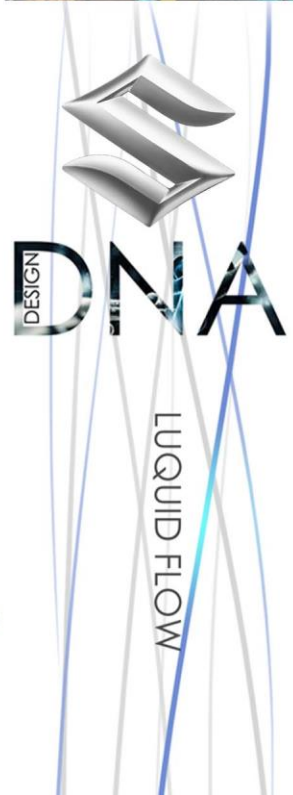

Inspired By India For India

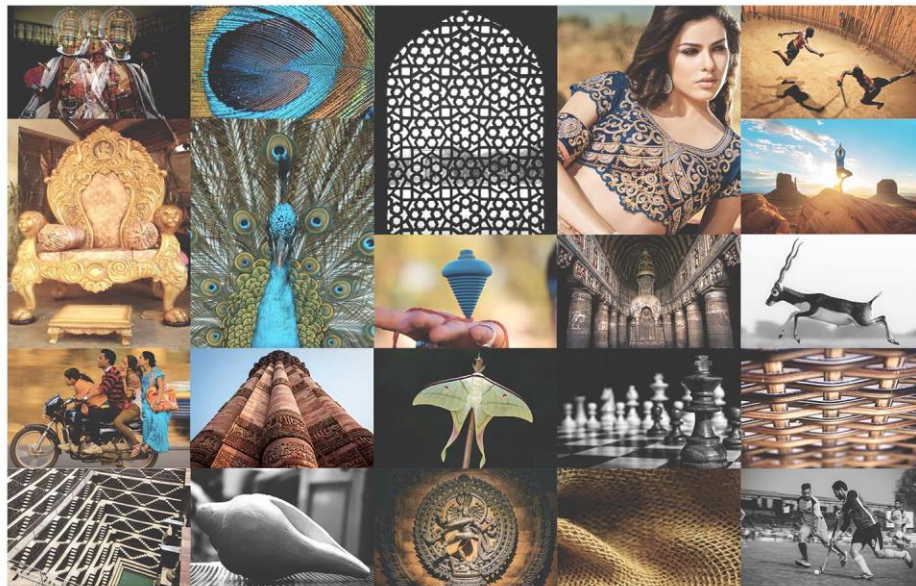

INSPIRATION
प्रेरणा

CONCISE
FLUTED
FIDELITY



Exploring Different Postures
of the Beautiful and Rare
Indian Moon Moth

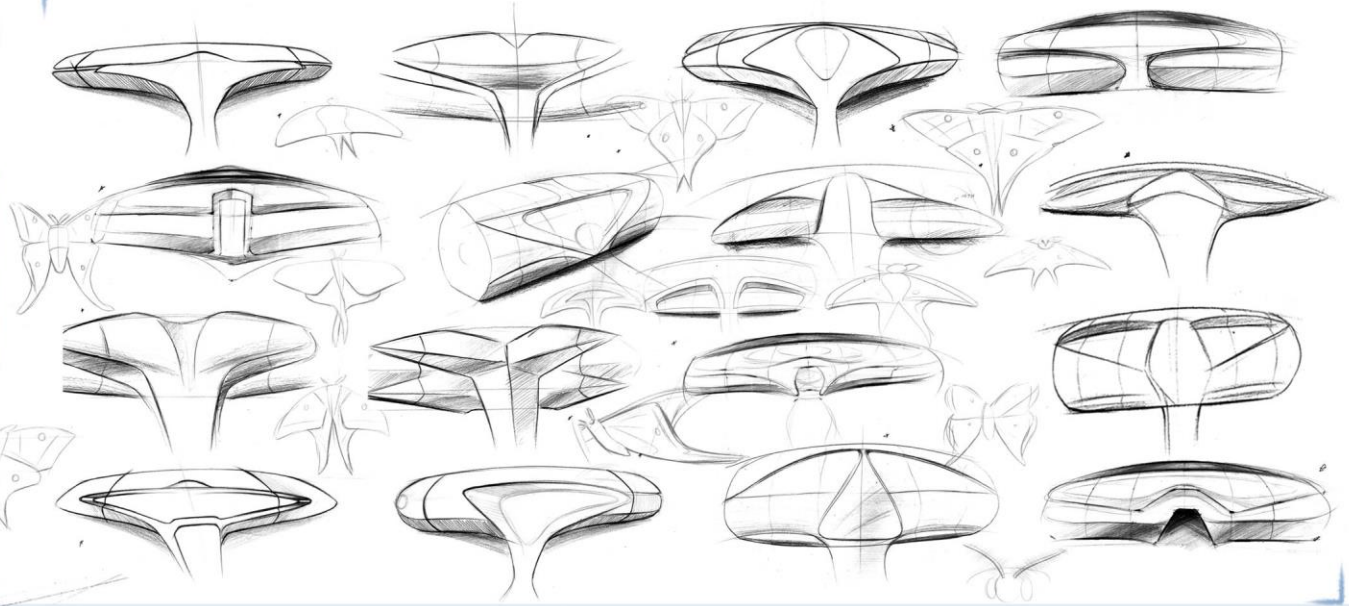

Directions

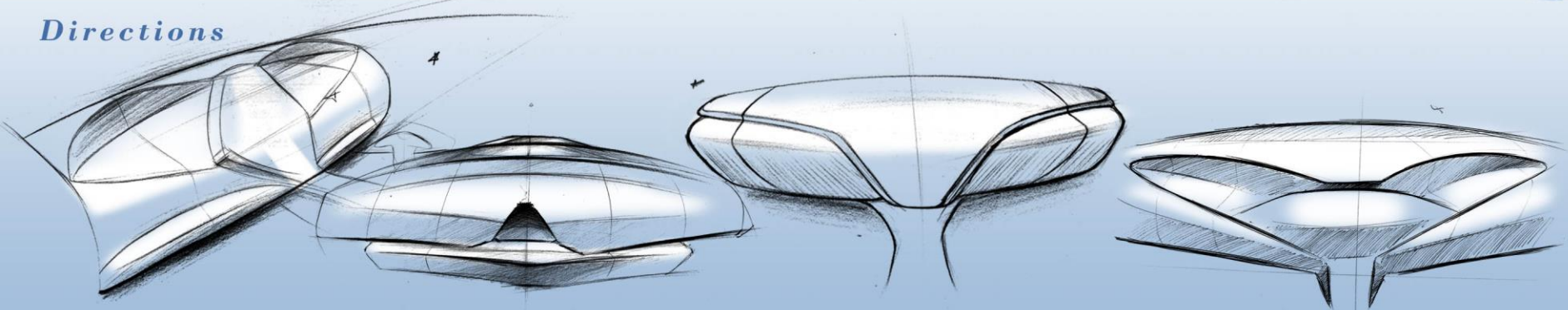

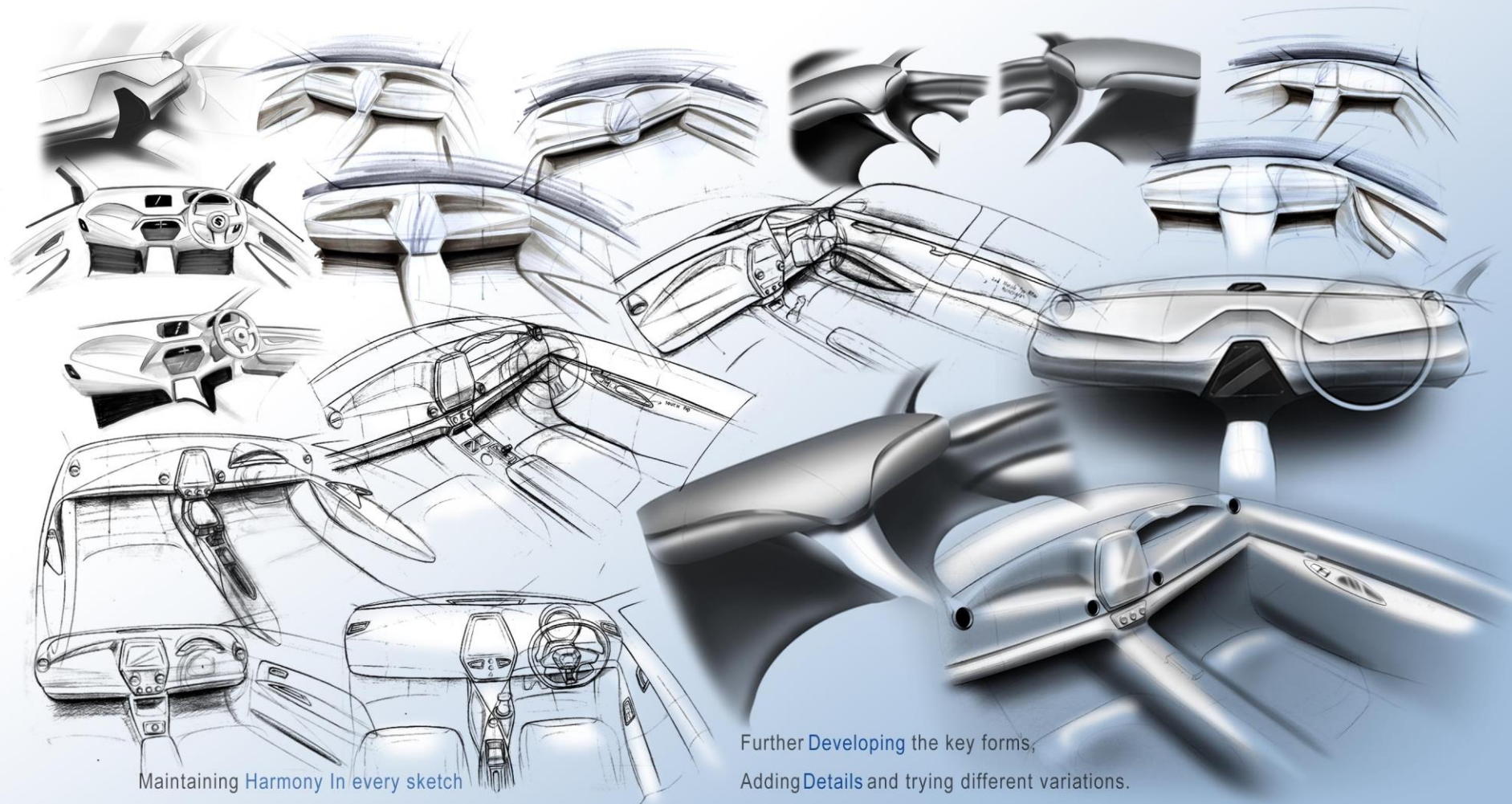

Maintaining Harmony In every sketch

Further Developing the key forms,
Adding Details and trying different variations.

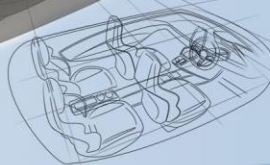
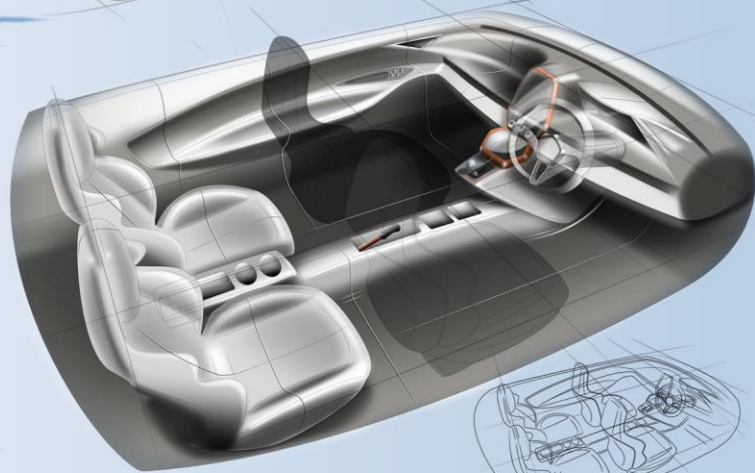
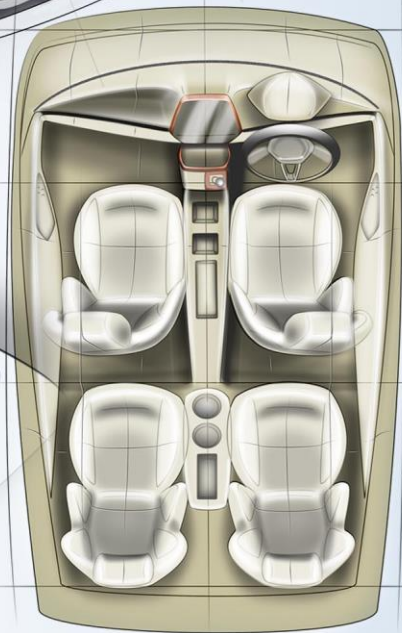
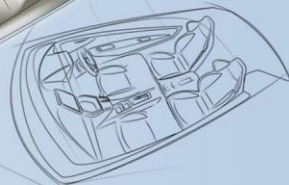
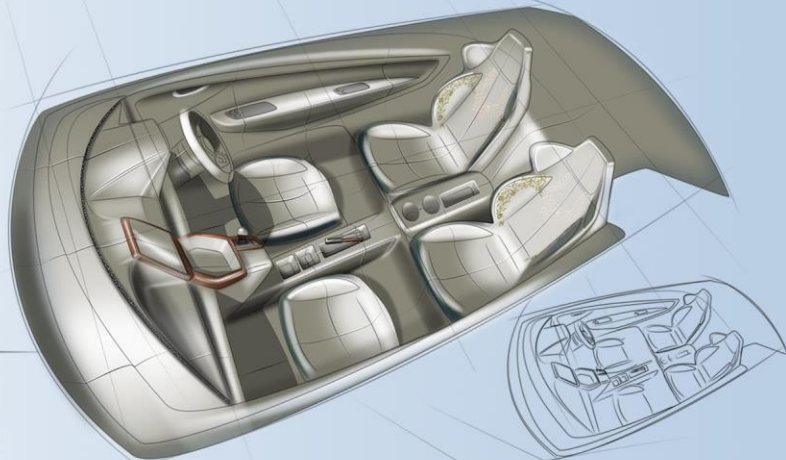
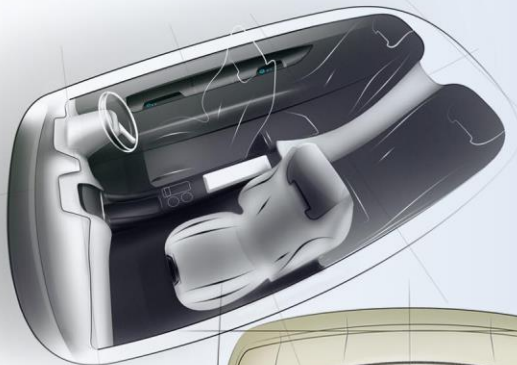

Final Direction

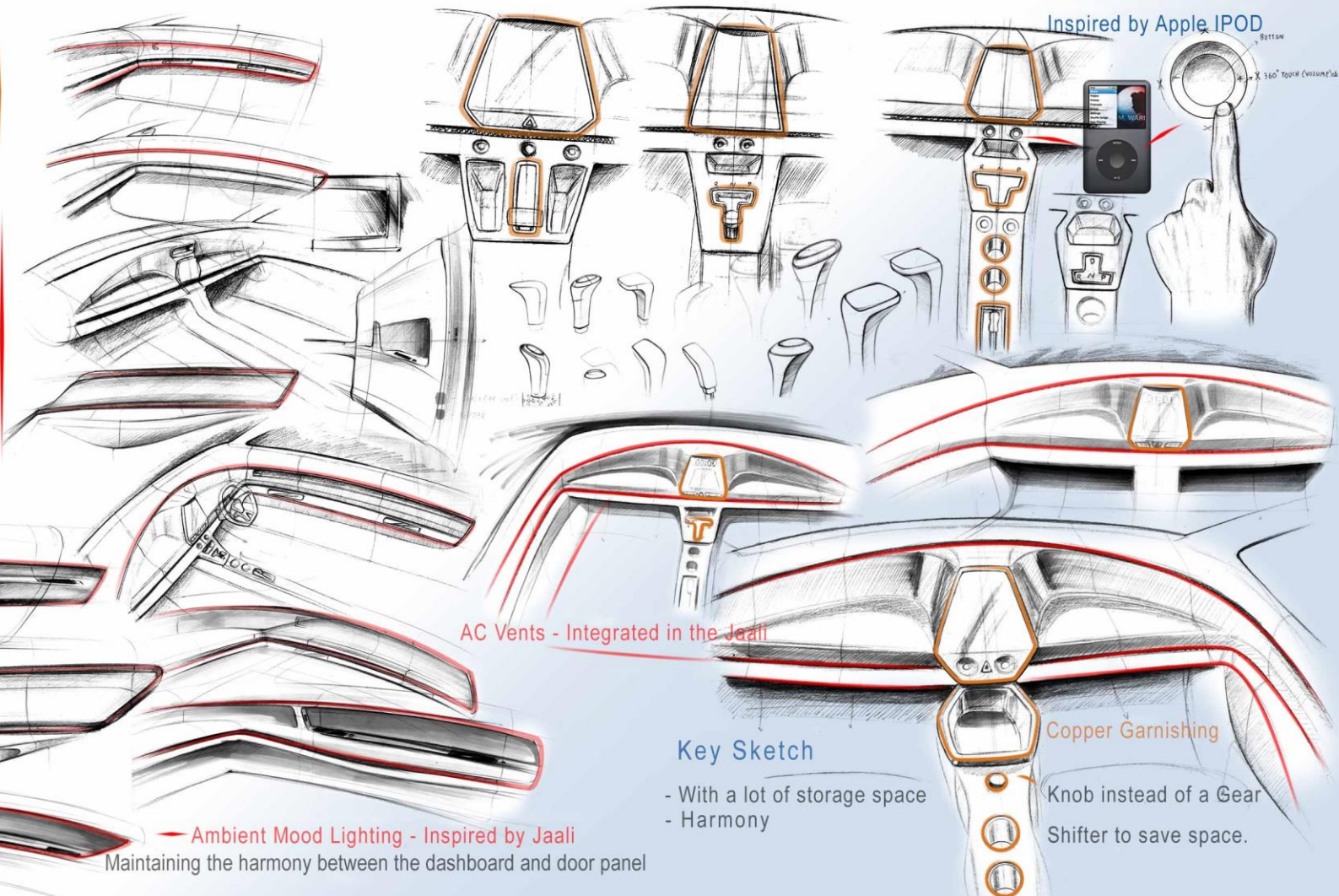
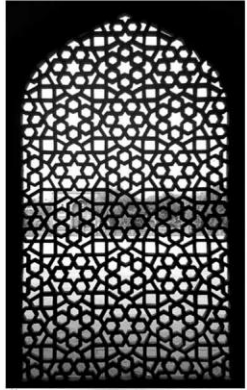

Inspired by Apple IPOD

Bottom
X 360° TOUCH (VOLUME)

AC Vents - Integrated in the Jaali

Key Sketch

- With a lot of storage space
- Harmony

Copper Garnishing

Knob instead of a Gear
Shifter to save space.

Ambient Mood Lighting - Inspired by Jaali

Maintaining the harmony between the dashboard and door panel



Inspiration

King's Throne (Singhasan)

Indian Gold Embroidery (Zardosi)

Peacock (National Bird of India)

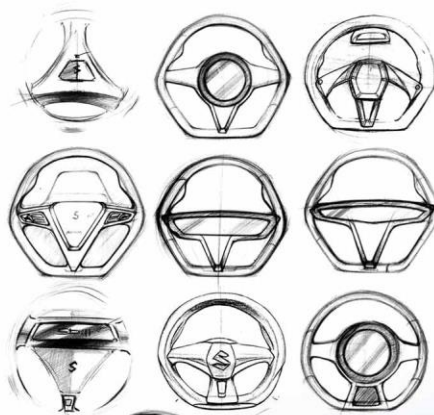
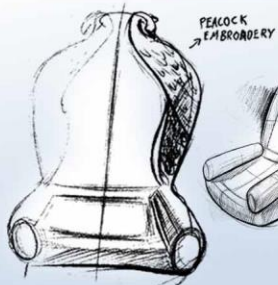

Initial Idea - Not to disturb the symmetry of dashboard. Placing the IP on steering wheel

Final Idea

Placing the IP on the steering column so that driver doesn't get distracted.

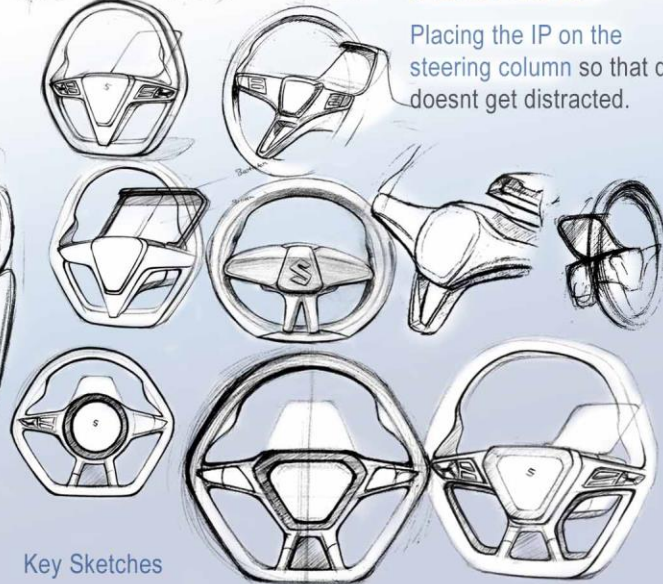

Key Sketches

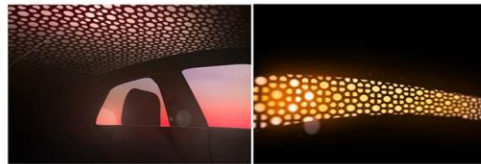
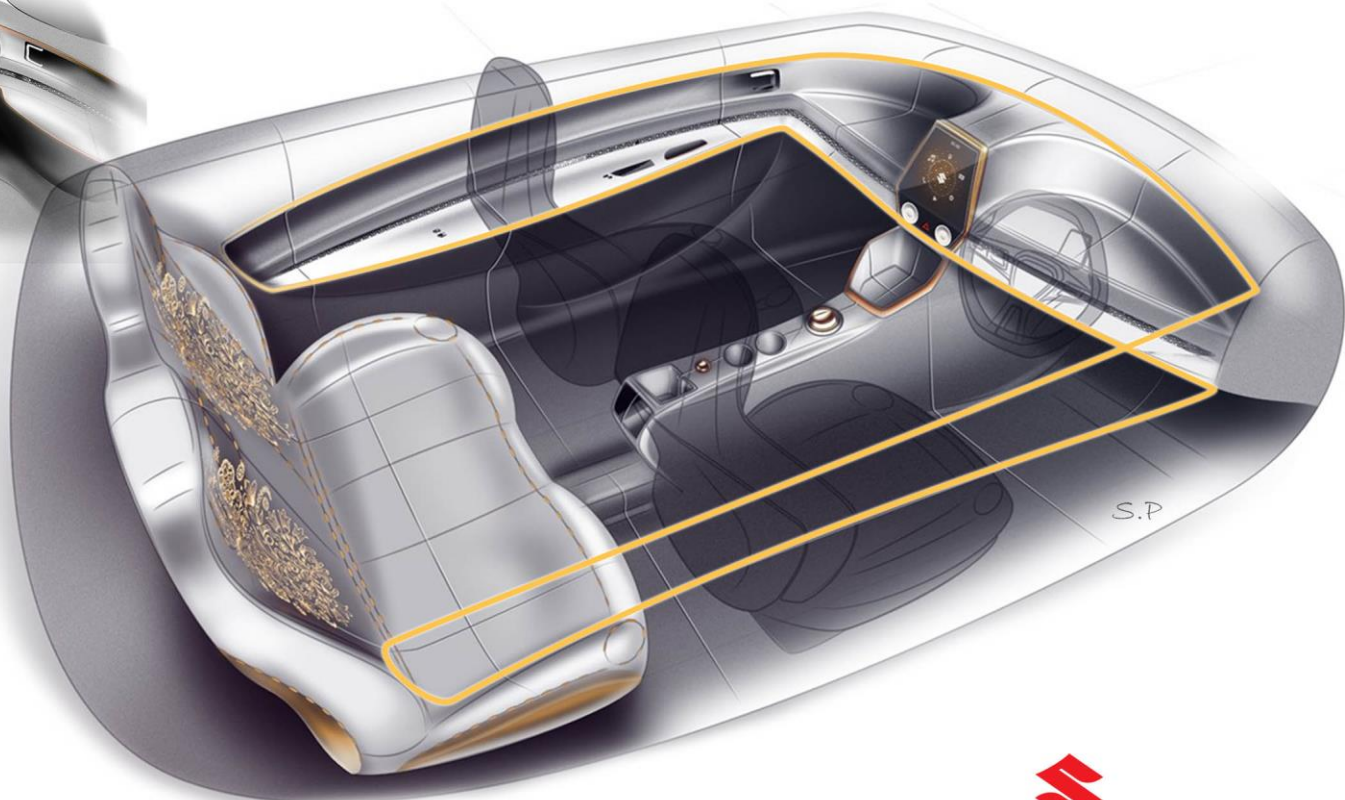
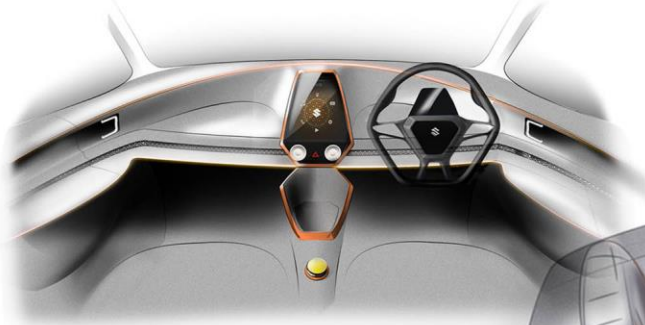

Final Concept

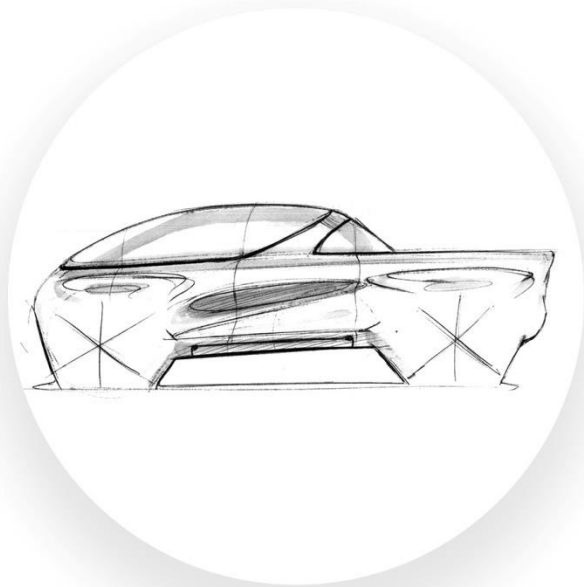

4

BharatBenz Pick-Up

Personal Project

Pick-Up Truck For The Modern Indian Farmers

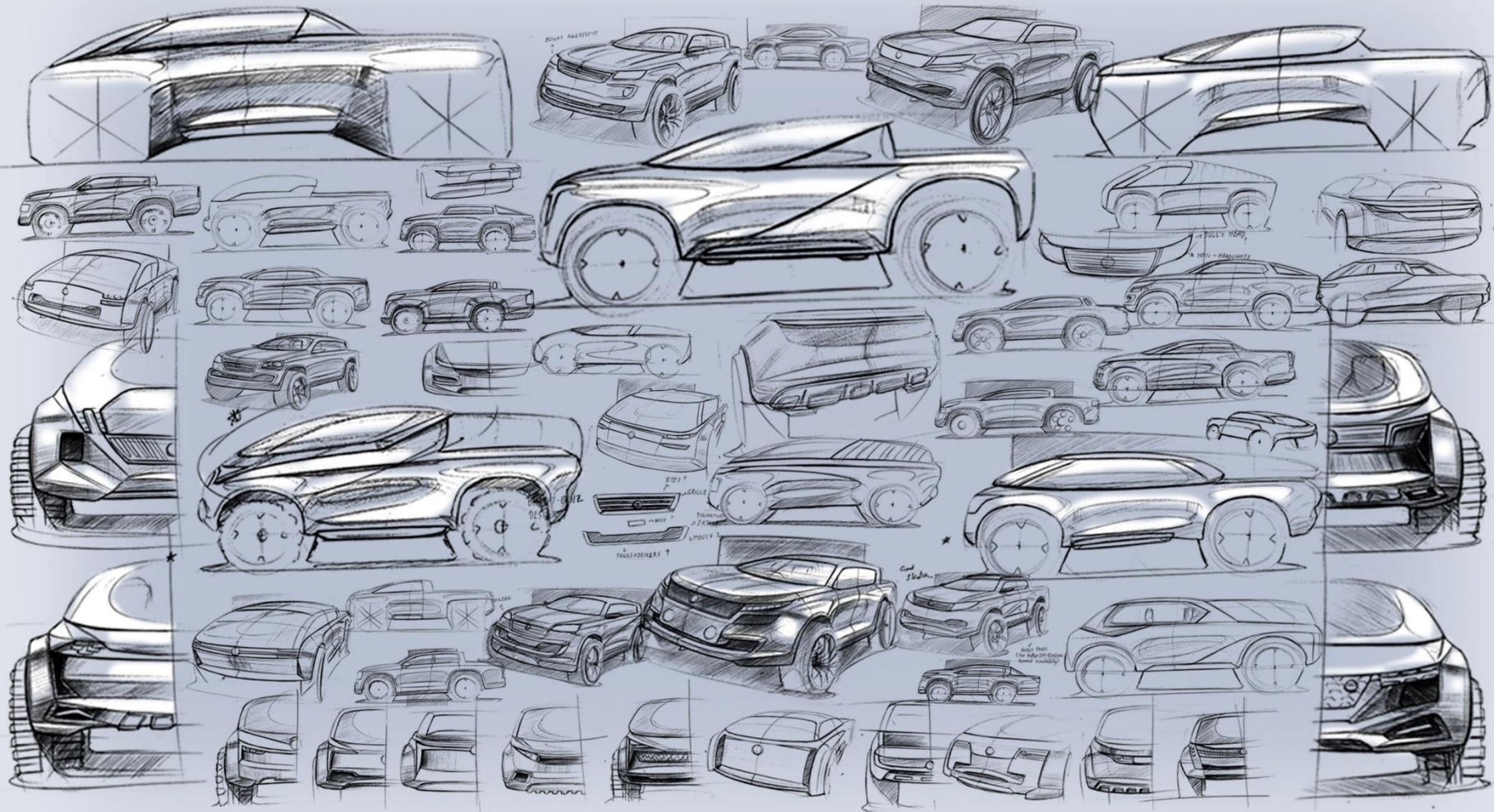

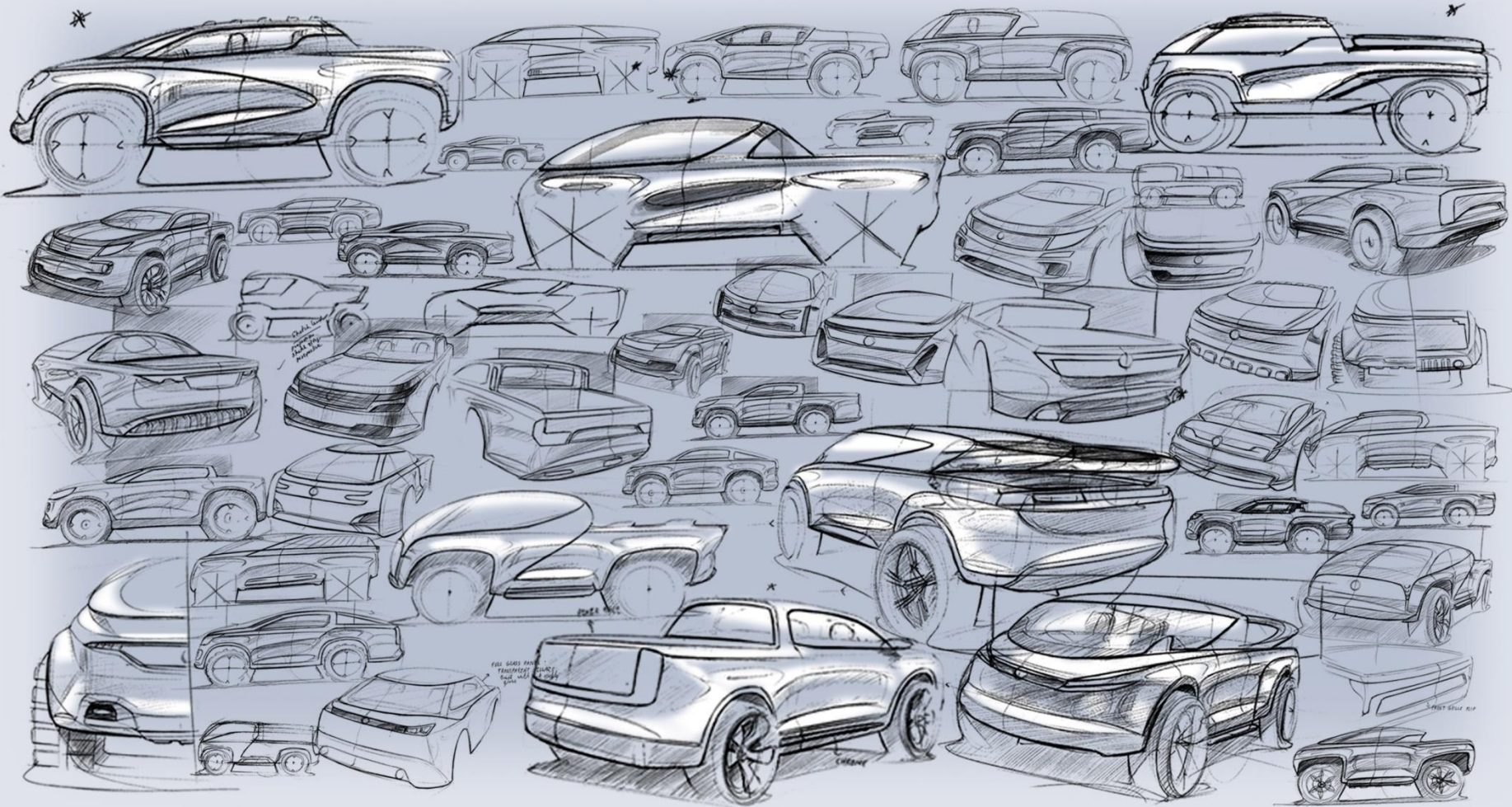

TOOK THE
WHEELS
OFF THE
MOTOR

FUEL GAUGE PANEL
TRANSPARENT

CREEPER

1987 SUBARU

COMING SOON



5

Miscellaneous

Free Time Sketches and Illustrations

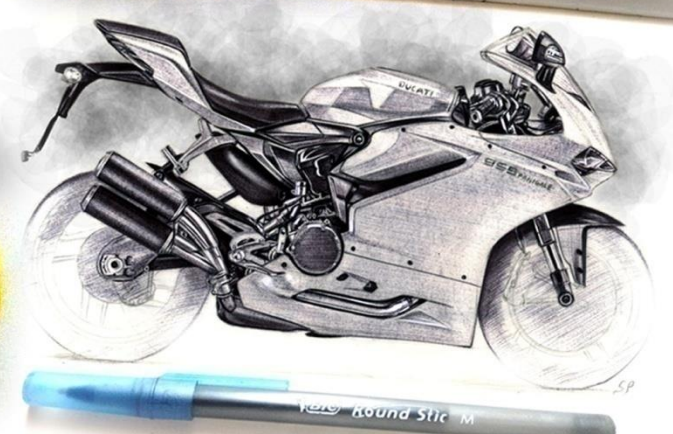
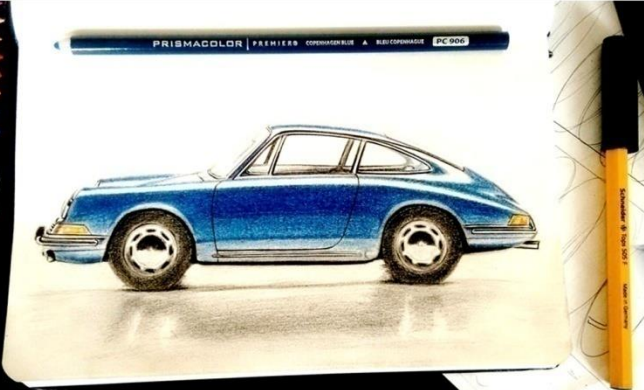

Sketchbook

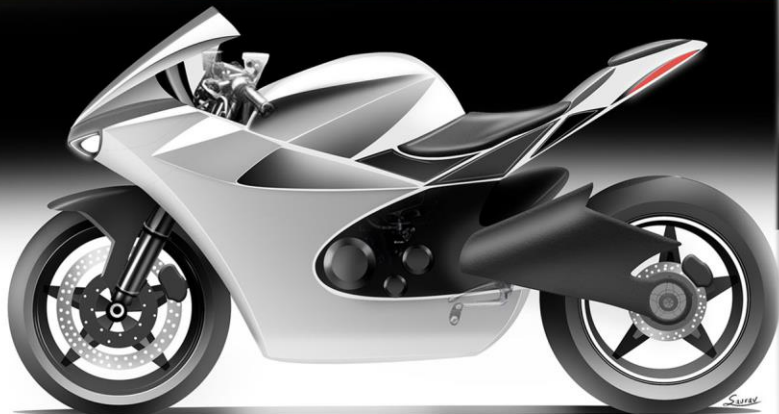

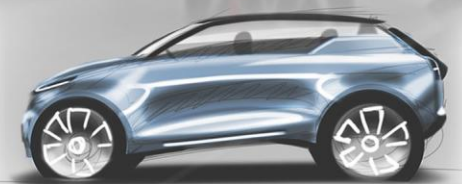
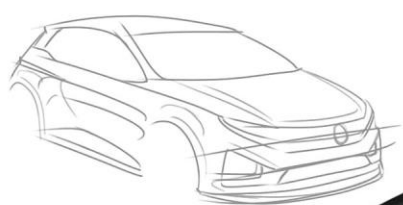



Portraiture

Eagerly waiting for your
Feedback & Suggestions

Thank You for your Precious Time.

Contact

sauravpand98@gmail.com

+91 966 517 2274

+91 800 710 9303

